







FUNZIONI E DOTAZIONI

	Versioni		
	STANDARD	IDROMASSAGGIO	PLUS
 Poggiatesta	●	●	●
 Rubinetteria meccanica a bordo vasca con cascata e doccetta	OPTIONAL	OPTIONAL	OPTIONAL
 Colonna di scarico	●	●	●
 Cromolight			●
 Disinfezione			●
 Seduta	●	●	●
 Pannello elettronico con funzioni HYDRO SEQUENCE		●	●
 Airpool dorsale 6 jets			●
 Airpool 10 jets			●
 Whirlpool 6 jets: regolazione portata e sistema di chiusura		●	●





SENSE 7 - Z1

Sense 7 - Z1

Sense 7 - Z1

vasca idromassaggio angolare

Misure	Capienza
cm 140x140	290 lt.

Vasca	Misure (cm)	Codice	Scelta struttura Prezzo
			senza pannelli 1 pannello

VERSIONE STANDARD

FUNZIONI E DOTAZIONI: 1 Poggiatesta, Seduta. Senza colonna di scarico

DA INCASSO	140 x 140 x 58 H	Z11140140-A		—
DA INCASSO CON RUBINETTERIA BORDO VASCA	140 x 140 x 58 H	Z111401402-A0K		—

FUNZIONI E DOTAZIONI: Telaio, Colonna di scarico, 1 Poggiatesta, Seduta

CON TELAIO	140 x 140 x 58 H	Z12140140-A1	—	
CON TELAIO E RUBINETTERIA BORDO VASCA	140 x 140 x 58 H	Z121401402-A1K	—	

VERSIONE IDROMASSAGGIO

FUNZIONI E DOTAZIONI: Whirlpool 6 jets, Telaio, Colonna di scarico, Pannello elettronico con funzioni Hydro Sequence, 1 Poggiatesta, Seduta

			OK	1K
CON TELAIO	140 x 140 x 58 H	Z15140140R0-A		
CON TELAIO E RUBINETTERIA BORDO VASCA	140 x 140 x 58 H	Z15140140R2-A		

VERSIONE PLUS

FUNZIONI E DOTAZIONI: Airpool 10 jets, Airpool Dorsali 6 jets, Whirlpool 6 jets, Telaio, Colonna di scarico, Pannello elettronico con funzioni Hydro Sequence, Cromolight, 1 Poggiatesta, Disinfezione, Seduta

			OK	1K
CON TELAIO	140 x 140 x 58 H	Z17140140R6-A		
CON TELAIO E RUBINETTERIA BORDO VASCA	140 x 140 x 58 H	Z17140140R7-A		

Esempio compilazione codice:

$$\text{Z15140140R0-A0K} = \text{Z15140140R0-A} + \text{OK}$$

Rubinetteria meccanica a bordo vasca con cascata e doccia

Seduta

Whirlpool 6 jets con regolazione portata e sistema di chiusura

Airpool dorsale 6 jets

Poggiatesta

Disinfezione

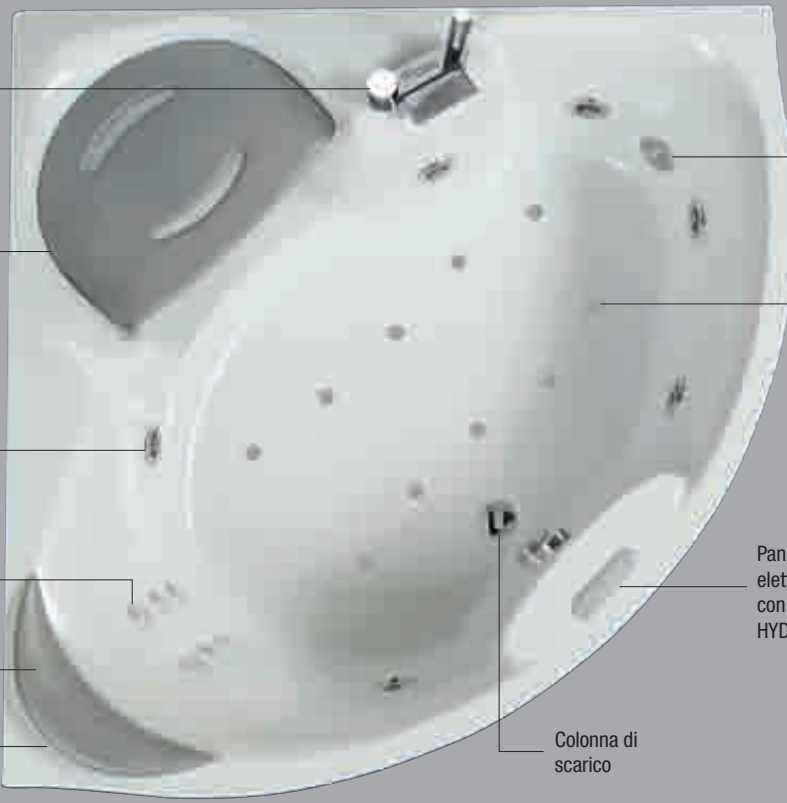

Cromolight

Airpool 10 jets

Pannello elettronico con funzioni HYDRO SEQUENCE

Colonna di scarico

OPTIONAL



Rubinetteria meccanica montaggio a pavimento

KRUBBVAS-K



Colonna di scarico

COLSCAVK-K

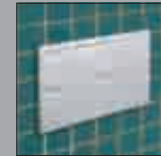

Pannello d'ispezione per vasca ad incasso

PANISPEL-A



Profilo di finitura rigido in alluminio

PRV140140-30

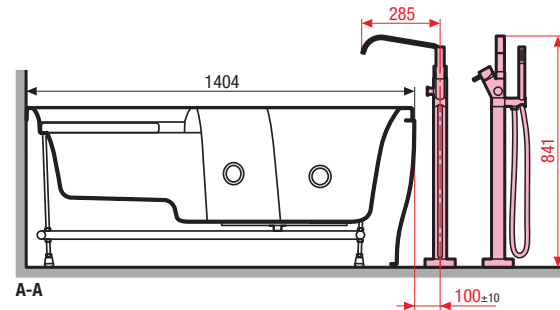
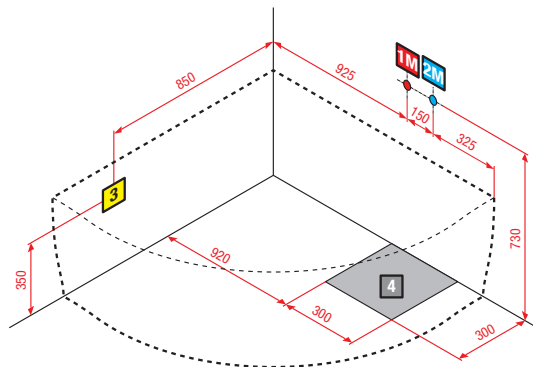
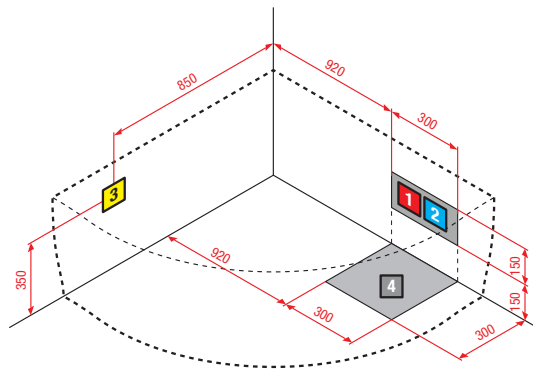

A-A

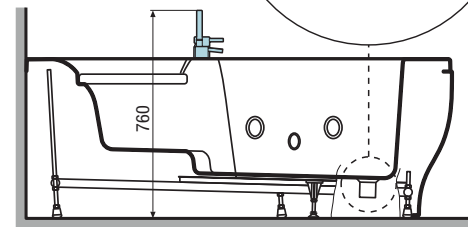
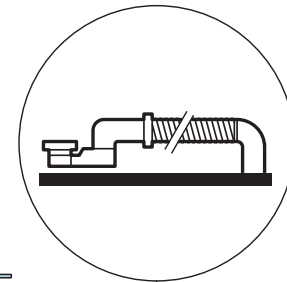

C-C



1M 2M Installazione a muro (non fornito)

4 Area consigliata per lo scarico a pavimento

5 Area disponibile per il posizionamento della rubinetteria a pavimento

Installare a monte dell'apparecchio un interruttore differenziale da 30mA provvisto di interruttore onnipolare con apertura minima dei contatti ≥ 3 mm.

CARATTERISTICHE IDRAULICHE

- 6 bocchette whirlpool
- 10 bocchette airpool
- 6 bocchette airpool dorsale
- Allaccio sifone con raccordo 1 1/2"

CARATTERISTICHE ELETTRICHE

- Tensione 220-230 V
- Frequenza 50 Hz
- Potenza massima assorbita: whirlpool 880 W, airpool 900 W, whirlpool + airpool: 1800 W